

# PQHA All Novice Show

## Hunt Seat Equitation (L1 Am/Sel/youth)

Show Date: 05-01-2021

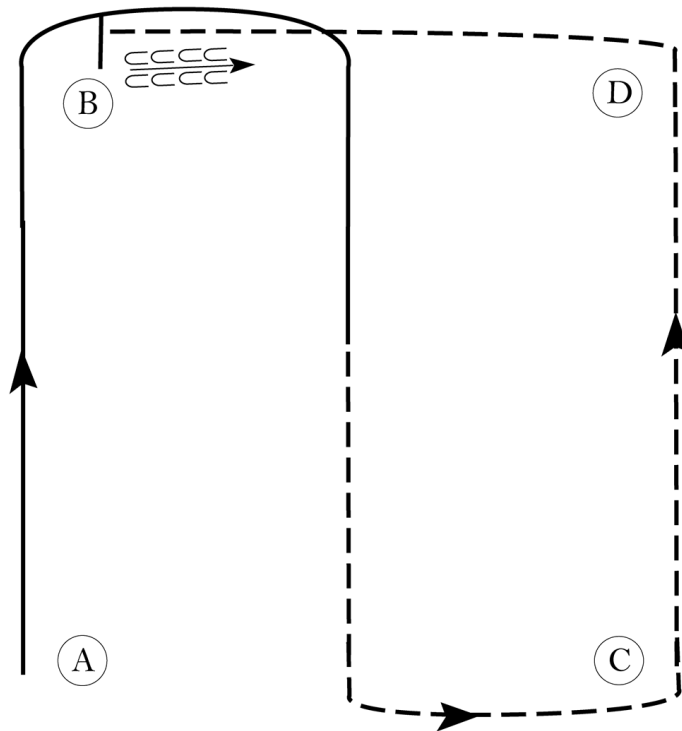

Be ready at A.

1. Canter on the right lead to and around B.
2. Halfway between B and C, break to the trot.
3. Posting trot on the right diagonal to C.
5. At C, change diagonals and continue to trot to D.
6. At D, sitting trot to B.
7. At B, stop and back one horse length.

Walk	-----
Trot	- - - - -
Extended Trot	— — — — —
Canter	—————
Leg Yield	
Lead Change	— / —
Back	← ← ← ← ←
Marker	ⓑ
Sidepass	← — — — — ←
Hand Gallop	— — — — —

[HSE/1-25]

Pattern Provided by:

*Lisa Farrell*

w w w . H o r s e S h o w P a t t e r n s . c o m

w w w . H o r s e S h o w P a t t e r n s . c o m

# PQHA All Novice Show

## Jackpot Equitation

Show Date: 05-01-2021

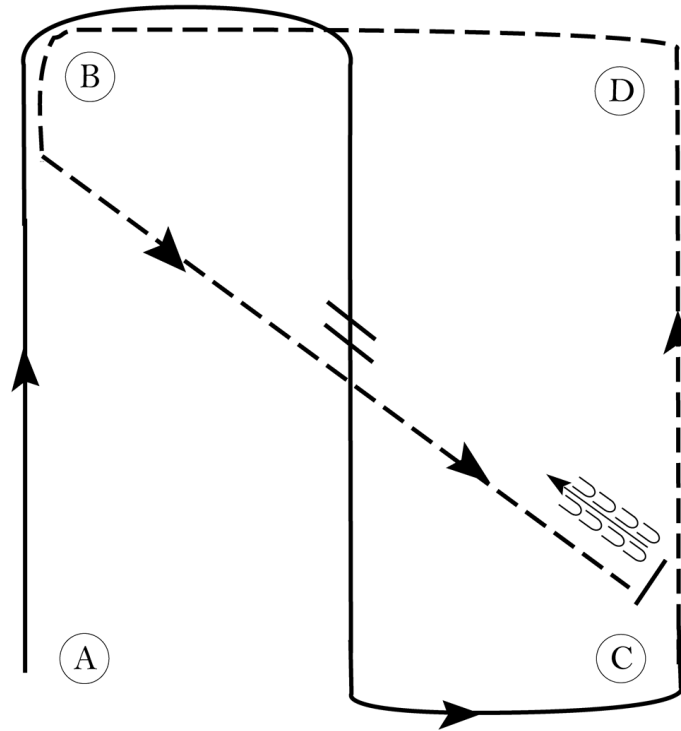

Be ready at A.

1. Canter on the right lead to and around B.
2. Halfway between B and C, change leads.
3. Canter on left lead to and around C.
4. Posting trot on the left diagonal from C to D.
5. At D, change diagonals and continue to trot to B.
6. At B, sitting trot to C.
7. Stop and back one horse length at C.

Walk	-----
Trot	- - - - -
Extended Trot	— — — —
Canter	—————
Leg Yield	
Lead Change	///
Back	←←←←
Marker	Ⓚ
Sidepass	←←←←
Hand Gallop	— — — —

[HSE/2-25]

Pattern Provided by:

*Lisa Farrell*

w w w . H o r s e S h o w P a t t e r n s . c o m

w w w . H o r s e S h o w P a t t e r n s . c o m

# PQHA All Novice Show

## L1 Showmanship (L1 Am/Sel/youth)

Show Date: 05-01-2021

w w w . H o r s e S h o w P a t t e r n s . c o m

w w w . H o r s e S h o w P a t t e r n s . c o m

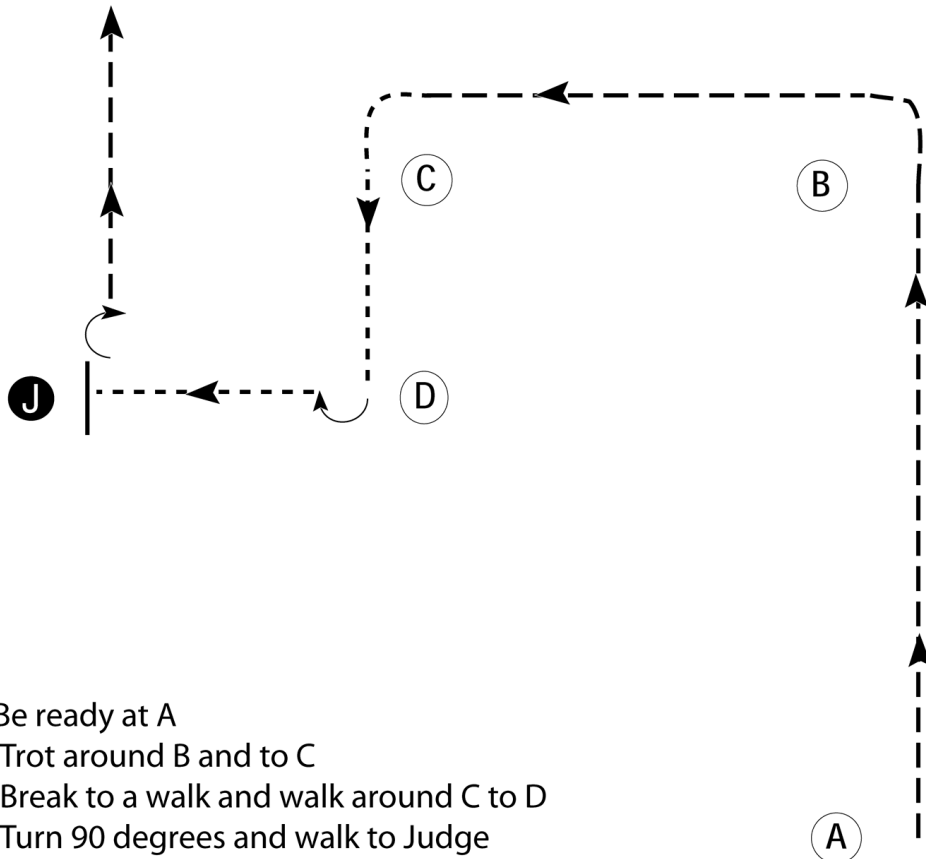

1. Be ready at A
2. Trot around B and to C
3. Break to a walk and walk around C to D
4. Turn 90 degrees and walk to Judge
5. Stop and set up for inspection
6. When dismissed, turn 90 degrees and trot away from judge

- Walk - - - - -
- Trot - - - - -
- Back ←
- Marker (B)
- Judge (J)

[S/1-16]

Pattern Provided by:

*Lisa Farrell*

# PQHA All Novice Show

## Jackpot Showmanship

Show Date: 05-01-2021

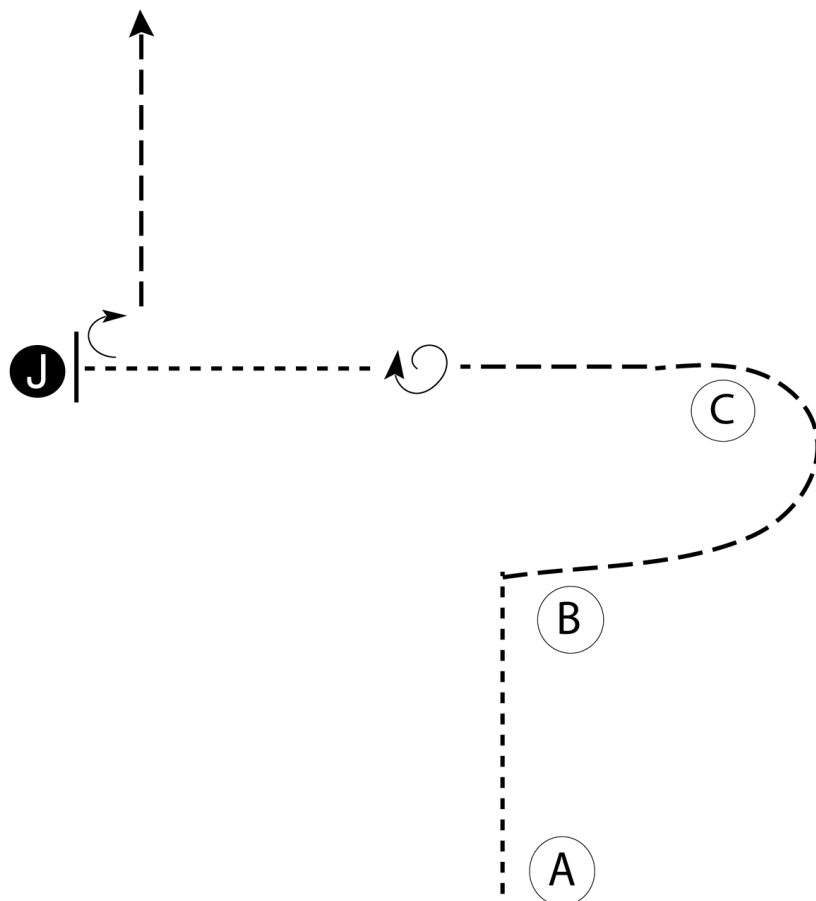

Be ready at A.

1. Walk to B.
2. Trot from B and around C as shown.
3. Halfway between C and the judge, stop and do a 360 degree turn.
4. Walk to judge and set up for inspection.
5. When dismissed, do a 90 degree turn and trot away.

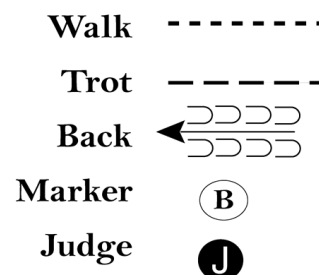

[S/2-21]

Pattern Provided by:

*Lisa Farrell*

# PQHA All Novice Show

## Showmanship (W/T)

Show Date: 05-01-2021

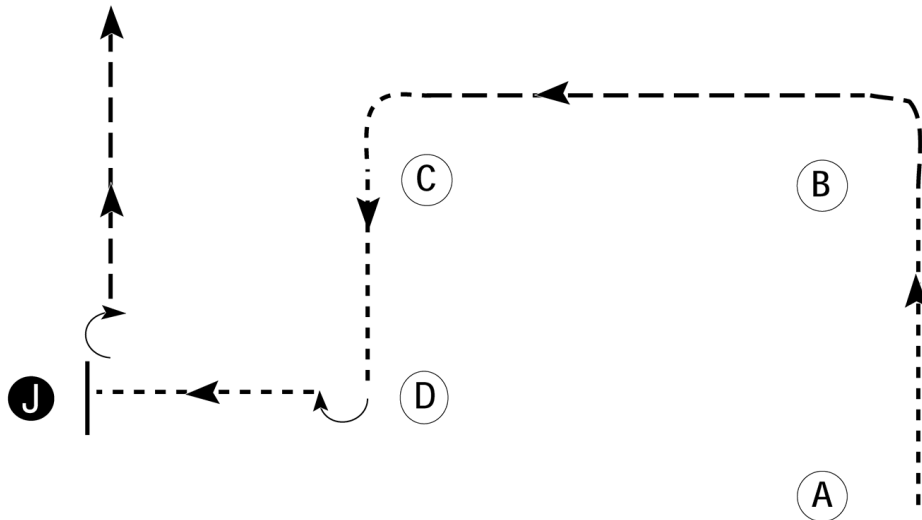

1. Be ready at A
2. Walk to B
3. Trot from B to C
4. Break to a walk and walk around C to D
5. Turn 90 degrees and walk to Judge
6. Stop and set up for inspection
7. When dismissed, turn 90 degrees and trot away from judge

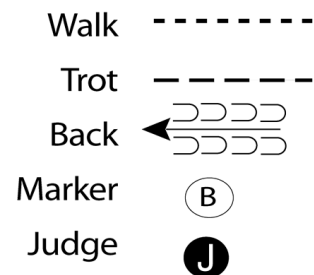

[SWT-5]

Pattern Provided by:

*Lisa Farrell*

w w w . H o r s e S h o w P a t t e r n s . c o m

w w w . H o r s e S h o w P a t t e r n s . c o m

# PQHA All Novice Show

## Equitation (W/T)

Show Date: 05-01-2021

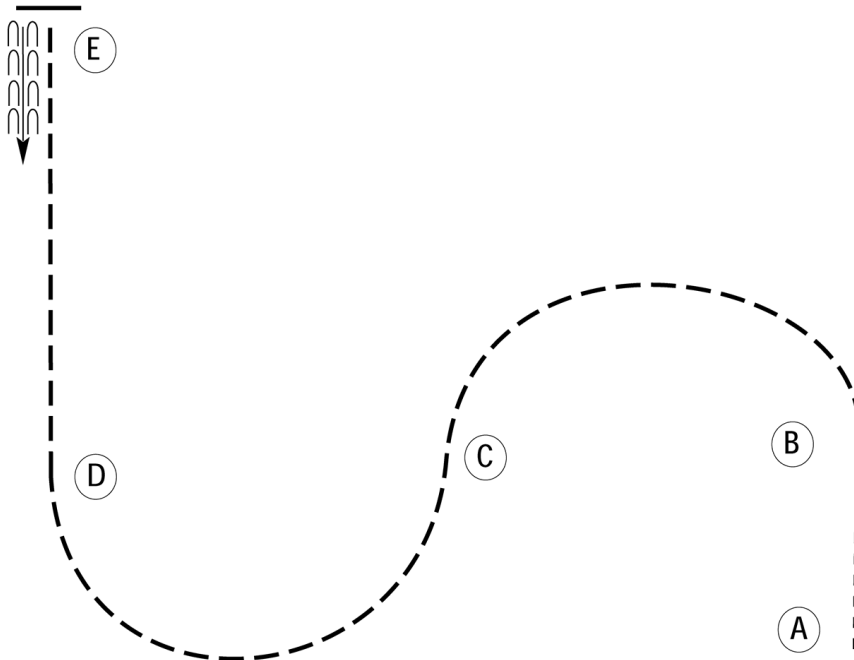

Be ready at A.

1. Walk from A to B.
2. Sitting trot from B to C.
3. Posting trot on the left diagonal from C to D.
4. Change diagonals at D.
5. Posting trot on the right diagonal from D to E.
6. Stop at E. Back approximately one horse length.
7. Follow the instructions of your ring steward.

Walk	-----
Trot	- - - - -
Extended Trot	— — — — —
Canter	—————
Leg Yield	
Lead Change	— / —
Back	←←←←←
Marker	Ⓚ
Sidepass	← — — — — →
Hand Gallop	— — — — —

[HSE/WT-17]

Pattern Provided by:

*Lisa Farrell*

w w w . H o r s e S h o w P a t t e r n s . c o m

w w w . H o r s e S h o w P a t t e r n s . c o m

# PQHA All Novice Show

## Horsemanship (L1 Am/Sel/youth)

Show Date: 05-01-2021

1. Walk A to B.
2. At B jog to C.
3. Stop at C and perform a 180 degree turn on the hindquarter to the right.
4. Jog C to B.
5. Stop at B and perform a 270 degree turn to the right on the hindquarter.
6. Lope on the left lead to D.
7. At D stop and back three steps.

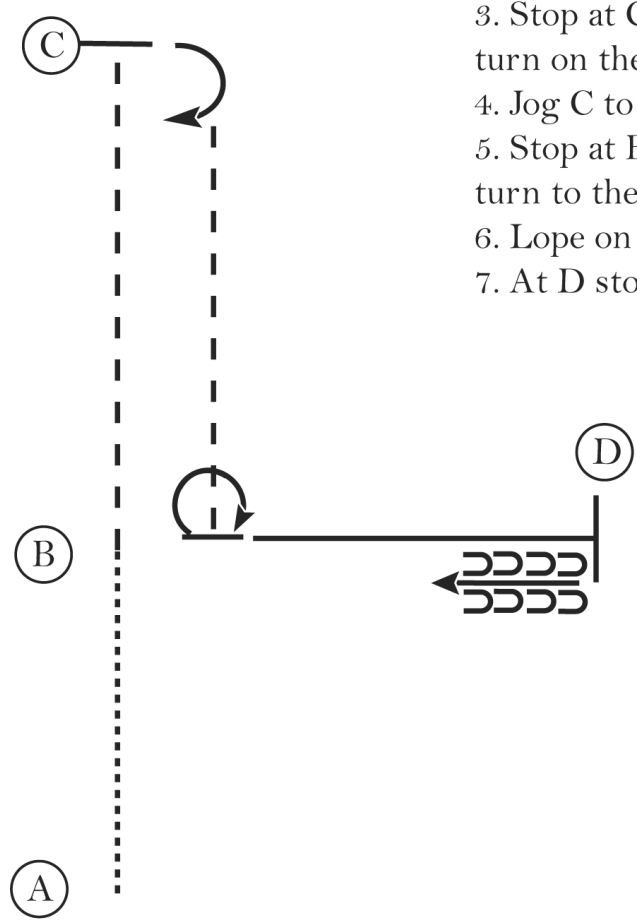

Walk	.....
Jog	-----
Extended Jog	-----
Lope	————
Leg Yield	
Lead Change	↘
Back	←←←
Marker	Ⓚ
Sidepass	←←←

[WH/1-13]

Pattern Provided by:

*Lisa Farrell*

w w w . H o r s e S h o w P a t t e r n s . c o m

w w w . H o r s e S h o w P a t t e r n s . c o m

# PQHA All Novice Show

## Jackpot Horsemanship

Show Date: 05-01-2021

w w w . H o r s e S h o w P a t t e r n s . c o m

w w w . H o r s e S h o w P a t t e r n s . c o m

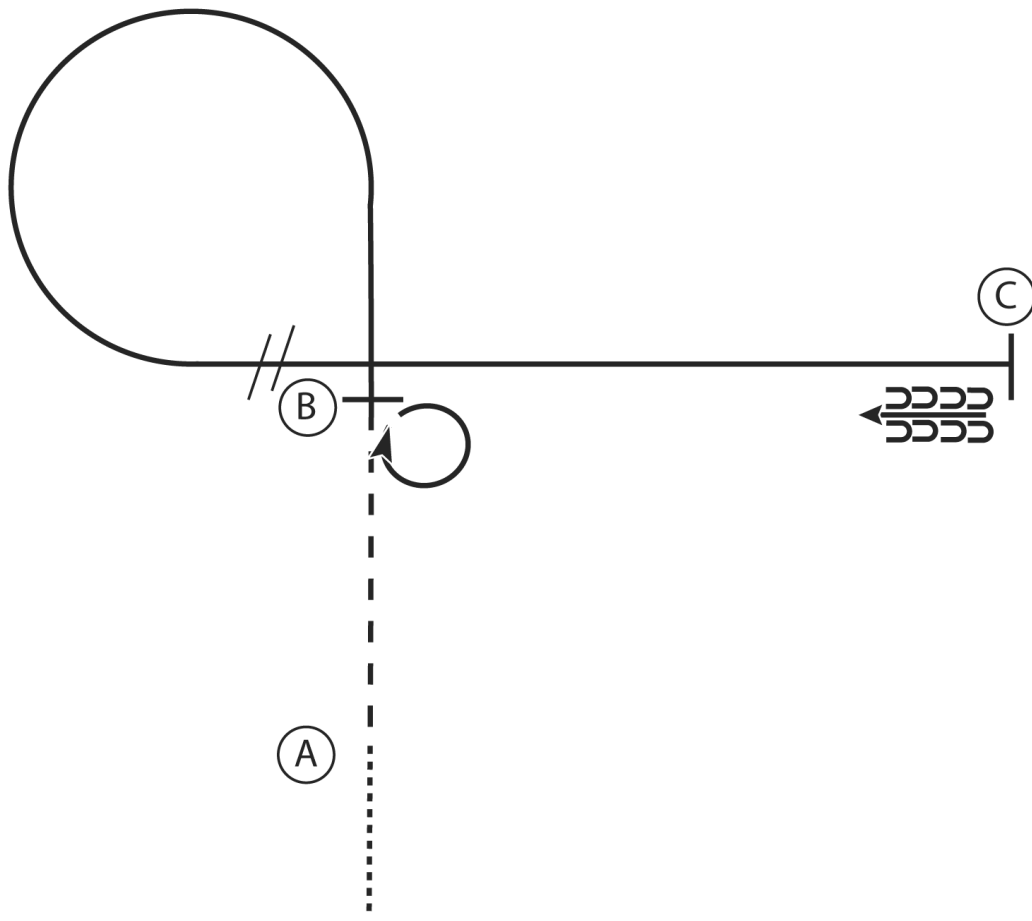

1. Walk to A
2. At A jog to B
3. Stop at B and perform a 360 degree turn to the right
4. Lope a circle to the left
5. At B perform a lead change and continue to C
6. At C stop and back 5 steps

Walk	.....
Jog	-----
Extended Jog	-----
Lope	—————
Leg Yield	
Lead Change	↙
Back	←←←←←
Marker	(B)
Sidepass	←←←←←

[WH/2-10]

Pattern Provided by:  
*Lisa Farrell*



# PQHA All Novice Show

## Small Fry Horsemanship

Show Date: 05-01-2021

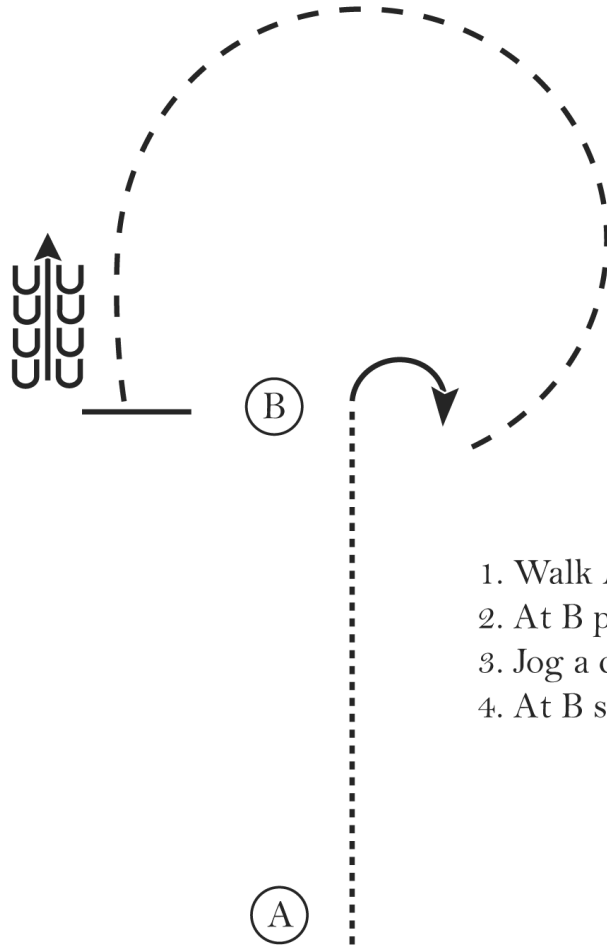

1. Walk A to B
2. At B perform a 90 degree turn to the right
3. Jog a circle around B
4. At B stop and back 4 steps

Walk	.....
Jog	-----
Extended Jog	-----
Lope	—————
Leg Yield	
Lead Change	↘
Back	← ← ← ←
Marker	(B)
Sidepass	←-----←

[WH/WT-7]

Pattern Provided by:

*Lisa Farrell*